

pergola Simply

 **SPRECH**
outdoor concept



pergola **Simply**

 **SPRECH**
outdoor concept

I plus di Simply

1 Struttura in alluminio con piastra di base in acciaio INOX

- Aluminum structure with stainless steel base plate
- Structure en aluminium avec plaque de base en acier inoxydable

2 Massima pulizia estetica sull'attacco a parete, grazie al fissaggio a scomparsa

- Maximum aesthetic cleanliness at the wall attachment, thanks to the concealed fixing
- Propreté esthétique maximale au niveau de la fixation murale, grâce à la fixation dissimulée.

3 Montanti regolabili in altezza

- Height-adjustable uprights
- Montants réglables en hauteur

4 Scarico dell'acqua integrato nei montanti

- Integrated water drainage in the uprights
- Évacuation d'eau intégrée dans les montants

5 Illuminazione integrata sulle traverse scorrevoli

- Integrated lighting on the sliding crossbars
- Éclairage intégré sur les traverses coulissantes

6 Copertura in membrana tessile oscurante con movimentazione automatizzata (modulo singolo con movimentazione di base manuale inclusa).

- Blackout textile membrane covering with automated operation (single module with basic manual operation included).
- Couverture en membrane textile occultante avec manœuvre automatisée (module simple avec manœuvre manuelle de base incluse)

7 Massima facilità di montaggio

- Maximum ease of installation
- Facilité maximale de montage



Garanzia e qualità del Made in Italy

Made in Italy guarantee and quality · Garantie et qualité du Made in Italy

IT

Simply è una pergola che fa della leggerezza la sua forza.

Un segno architettonico pulito, essenziale, capace di dialogare con l'edificio e creare nuovi spazi d'ombra in ambito residenziale.

La struttura in alluminio, solida ma visivamente leggera, è completata da piastre di base in acciaio inox, garanzia di stabilità e durabilità.

L'attacco a parete, con fissaggio a scomparsa, assicura la massima continuità visiva e una pulizia formale impeccabile.

Simply si adatta con facilità a contesti e necessità diverse grazie ai **montanti regolabili in altezza** e a un sistema progettato per una rapida installazione.

L'acqua piovana viene gestita attraverso lo scarico integrato nei montanti, preservando l'estetica lineare della pergola e il comfort dello spazio sottostante.

La copertura, realizzata in membrana tessile oscurante, protegge efficacemente da raggi UV, pioggia e vento, permettendo di modulare luce e ombra in base al momento della giornata.

L'illuminazione integrata sulle traverse scorrevoli completa l'esperienza, rendendo lo spazio fruibile anche nelle ore serali, con una luce diffusa e funzionale.

EN

Simply is a pergola that makes lightness its strength.

A clean, essential architectural statement, designed to interact harmoniously with the building and create new shaded spaces in residential settings.

The aluminum structure, solid yet visually light, is complemented by stainless steel base plates, ensuring stability and durability. The wall connection, with concealed fixing, guarantees maximum visual continuity and impeccable formal cleanliness.

Simply easily adapts to different contexts and requirements thanks to its height-adjustable posts and a system designed for quick installation.

Rainwater is managed through drainage integrated into the posts, preserving the pergola's linear aesthetics and the comfort of the space below.

The cover, made of blackout textile membrane, effectively protects against UV rays, rain, and wind, allowing light and shade to be adjusted according to the time of day. Integrated lighting on the sliding crossbeams completes the experience, making the space usable even in the evening hours, with soft and functional illumination.

FR

Simply est une pergola qui fait de la légèreté sa force.

Un signe architectural épuré et essentiel, capable de dialoguer avec le bâtiment et de créer de nouveaux espaces ombragés dans un contexte résidentiel.

La structure en aluminium, solide mais visuellement légère, est complétée par des platines de base en acier inoxydable, garantissant stabilité et durabilité. La fixation murale, avec ancrage dissimulé, assure une continuité visuelle maximale et une pureté formelle irréprochable.

Simply s'adapte facilement à différents contextes et besoins grâce à ses montants réglables en hauteur et à un système conçu pour une installation rapide.

Les eaux pluviales sont gérées grâce à un système d'évacuation intégré dans les montants, préservant l'esthétique linéaire de la pergola et le confort de l'espace sous-jacent.

La couverture, réalisée en membrane textile occultante, protège efficacement contre les rayons UV, la pluie et le vent, permettant de moduler la lumière et l'ombre selon le moment de la journée. L'éclairage intégré sur les traverses coulissantes complète l'expérience, rendant l'espace utilisable également en soirée, avec une lumière diffuse et fonctionnelle.



pergola Simply

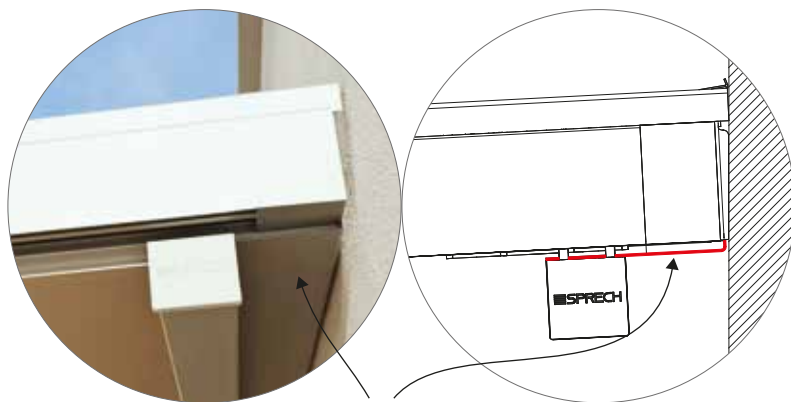

Carter-parete in alluminio Aluminium wall casing - Carter mural en aluminium

Il fissaggio a parete con attacco interno guida, garantisce un'eccellente continuità visiva; l'esclusivo carter completa ed esalta l'estetica essenziale, impeccabile e perfettamente pulita.

The wall mounting with concealed attachment ensures excellent visual continuity; the exclusive wall casing completes and enhances the essential, impeccable, and perfectly clean aesthetic.

La fixation murale avec support invisible garantit une excellente continuité visuelle ; le carter mural exclusif complète et met en valeur une esthétique essentielle, impeccable et parfaitement épurée.

pergola **Simply**

Regolazione dell'altezza dei montanti

L'innovativo sistema di regolazione dell'altezza dei montanti garantisce una corretta messa in bolla della gronda, assicurando precisione e semplicità di installazione. L'apposito carter completa la finitura alla base del montante.

Height adjustment of the uprights

The innovative system for adjusting the height of the uprights ensures correct leveling of the gutter, providing precision and ease of installation. The dedicated cover completes the finish at the base of the upright.

Réglage de la hauteur des montants

Le système innovant de réglage de la hauteur des montants garantit une mise à niveau correcte de la gouttière, assurant précision et simplicité d'installation. Le carter dédié complète la finition à la base du montant.

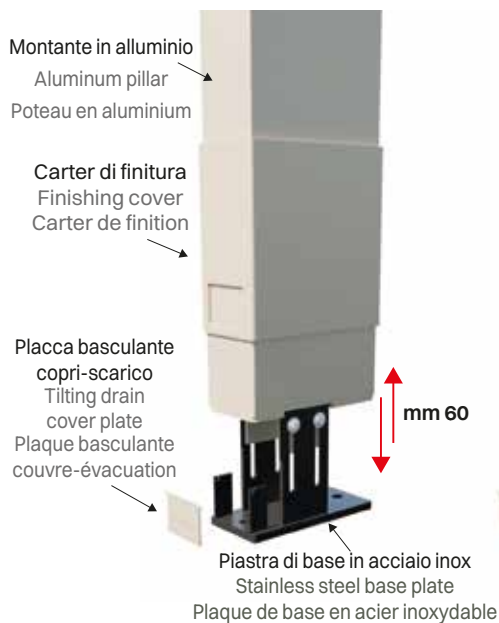

caratteristiche tecniche pergola Simply



1
Gronda
Gutter
Gouttière

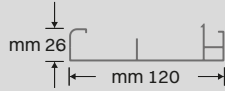

2
Profilo compensatore
Compensator profile
Profilo compensateur

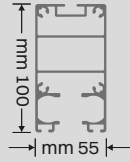

3
Guida
Rail
Rail

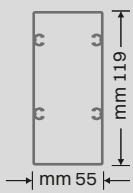
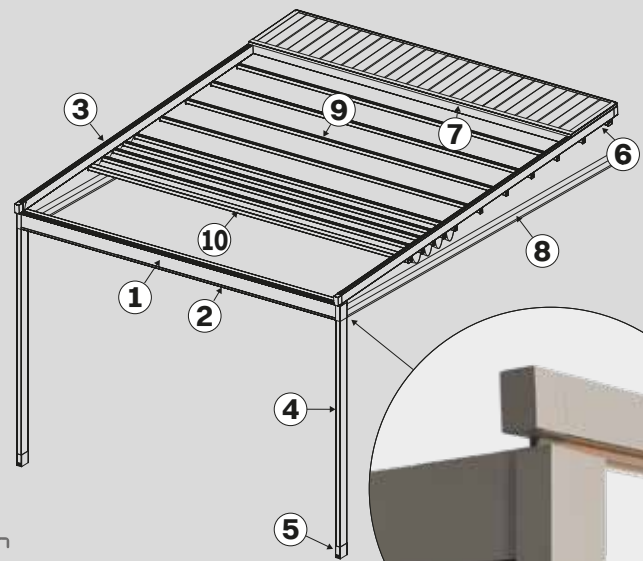

4
Montante
Pillar
Poteau

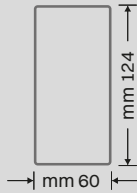

5
Carter
Casing
Carter

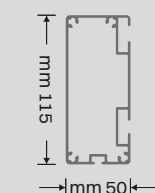

6
Trave supporto motore
Motor support beam
Poutre de support du moteur

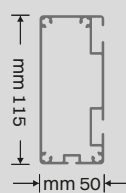

7
Trave supporto tettuccio
Roof support beam
Poutre de support du toit

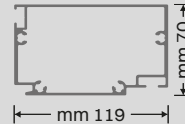

8
Trave laterale
Lateral beam
Poutre latéral

pergole con larghezza fino a cm 400
Pergolas with maximum width up to 400 cm
Pergolas avec largeur maximale jusqu'à 400 cm

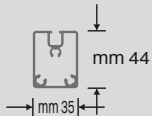

9
Frangitratta
senza illuminazione
Fabric support
without lighting system
Traverses coulissantes
sans éclairage

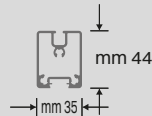

9
Frangitratta
con illuminazione (strip led)
Fabric support
with integrated Led strip lighting
Traverses coulissantes
avec éclairage intégré (bande LED)

pergole con larghezza superiore a cm 400
Pergolas with width exceeding 400 cm
Pergolas avec largeur supérieure à 400 cm

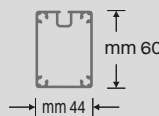

9
Frangitratta
senza illuminazione
Fabric support
without lighting system
Traverses coulissantes
sans éclairage

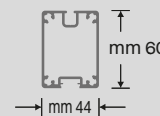

9
Frangitratta
con illuminazione (strip led)
Fabric support
with integrated Led strip lighting
Traverses coulissantes
avec éclairage intégré (bande LED)

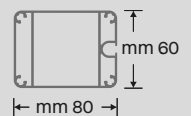

10
Frangitratta terminale
terminal fabric support
Traverse d'extrémité

Dimensioni / Dimensions

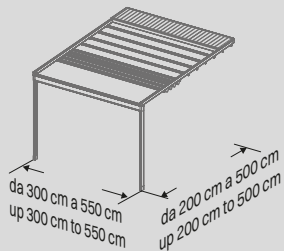

1 modulo
1 module

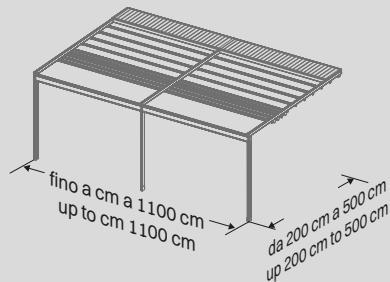

2 moduli
2 modules

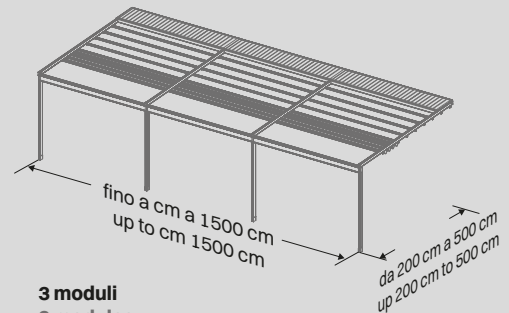

3 moduli
3 modules



pergola **Simply**



IT

La pergola **Simply** è disponibile in 41 colori e in **4 varianti limited Sprech Special Colors**, con certificazione Qualicoat Class 2, a garanzia di un'eccezionale superdurabilità con massimi livelli di ritenzione della brillantezza, stabilità del colore e resistenza ai raggi UV.

EN

The pergola **Simple** is available in 41 colours and in **four color variations limited edition Sprech Special Colors**, with Qualicoat Class 2 certification, a guarantee of exceptional durability with maximum levels of gloss retention, colour stability, and resistance to UV rays.

FR

La pergola **Simple** est disponible en 42 couleurs et **quatre variations de couleurs, édition limitée Sprech Special Couleurs**, avec la certification Qualicoat Class 2, en garantie d'une super-durabilité exceptionnelle avec des niveaux maximaux de retenue de la brillance, de stabilité de la couleur et de résistance aux rayons UV.



discover more

Prov. le Martano—Soleto Km. 1.500
73025 Martano (LE), Italy
(+39) 0836 57 14 16

•
www.sprech.com
info@sprech.com



outdoor concept